

ICS  **Cutting Tools, Inc.**

3/4"

**UNIVERSAL
CUTTER-GRINDER**

Operating Handbook

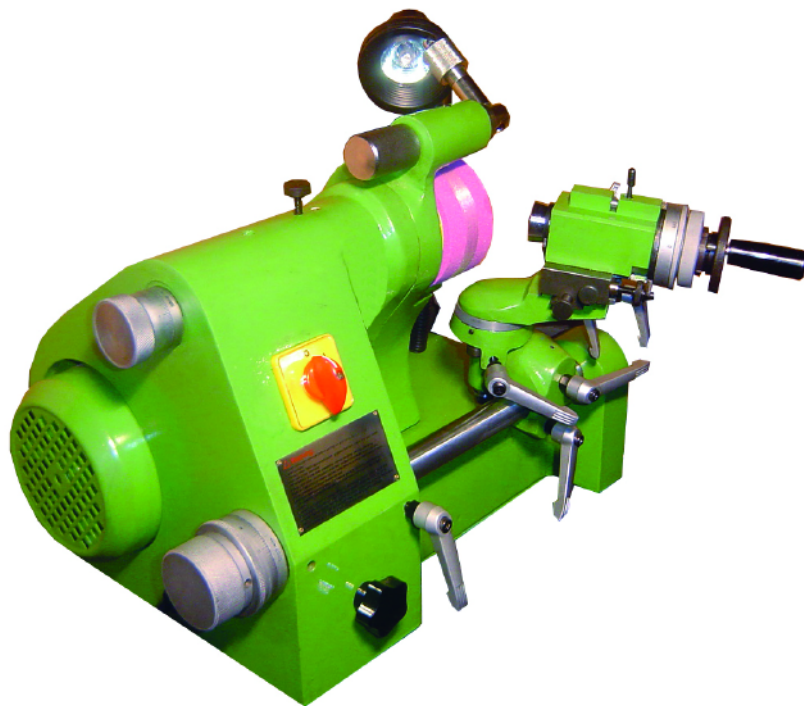

VOLTAGE 120V / 60 HZ
MOTOR R.P.M. 3.600 RPM

POWER REQ. 1/3 HP
MOTOR AMPS: 6.3 AMPS

CONTENTS

Nomenclature of Controls-----	1
Grinding Spindle -----	1
Servicing the Index Head Bracket-----	2
Dressing the Grinding Wheel-----	2
Cutter Profiles-Tool Angle-Cutting Speeds -----	3
Cutting Speeds-----	3
Centering the Cutter Lip by Grinding-----	4
Circular Grinding of Cutters -----	5
Grinding the Back Angle of Side Cutting Edges Circular Grinding of Cutters-----	6
Grinding the Back Rake Angle of End Cutting Edges (Straight) Circular Grinding of Cutters-----	6
Grinding the Back Rake Angle of End Cutting Edges(Round)Grinding Pointed Cutters-----	6
Grinding Tapered Cutters-----	8
Circular Grinding of Side and End Cutting Edges Grinding Tapered Cutters-----	8
Grinding the Back Rake Angle of Side and End Cutting Edges Grinding Tapered Cutters -----	9
Grinding the Back Rake Angle of Side and End Cutting Edges(round)Twist drill Grinding Attachment-----	9
Accessories -----	10
Operating Instructions-----	11

Nomenclature of Controls

D	Wheel dressing attachment	S3	Index head slide
A	Spring collect clamping quill	O	white dot window
T1	Cross slide clamping lever	S5	Index head slide fine adjustment set screw
S2	Vertical swivel mount setting scale	S4	Index head slide fine adjustment screw
T2	Vertical swivel mount clamping lever	Q	Cross slide
T3	Horizontal swivel mount clamping lever	T6	Index drum F clamping lever
T4	Tubular guide clamping lever	B1	Collect sleeve
F	Horizontal swivel mount index drum	U2	Screw
T7	Clamping lever for adjustment along tubular guide	A1	Stop plate for 90 degree
H	Index head bracket fine adjustment screw	U3	Screw for A1
G	Adjustable stop screw	N4	Index drum
T5	Index head slide clamping lever	N5	Ring nut
C	Cutter lip aligning gauge	E	Index ring bearing sleeve
C1	Cross slide venires scale for off-center radii	M3	Nut for index sleeve
P	Spring collect index pin	R7	Slotted disc
A3	Adjusting eccentric pin	M4	Nut

GRINDING SPINDLE

The spindle bearing has been factory-adjusted to exclude play while allowing for a free-running spindle. In the event some play develops in the course of time, such play should be taken up by tightening the two nuts M. for this purpose, pull spindle from its seat after having loosened screw S and removed the parts as indicated in the illustration on page 15 and relighting R. When tightening the nuts allow for a forerunning spindle. Excessive tightening would result in bearing failure. After reinserting the spindle assembly carefully tighten screw S in the bore, to hold the spindle assembly in position.

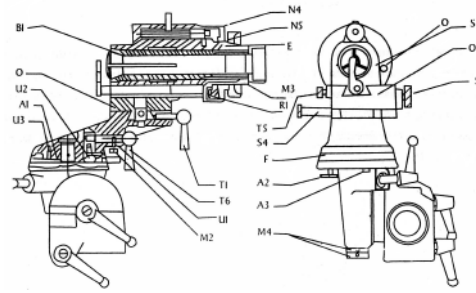
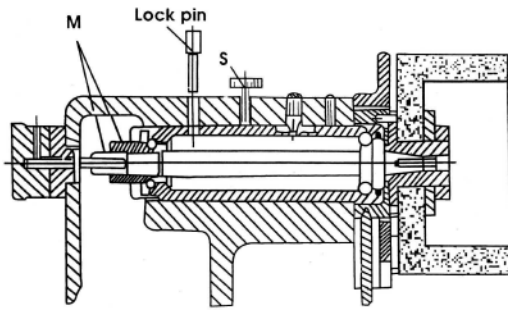

Servicing the Index Head Bracket

General

After a major period of use, it will be necessary to dismantle the index head bracket and to clean and lubricate the collect sleeve bearing, the index head slide, and the swivel arm.

Collect Sleeve Bearing

To remove the collect sleeve proceed as follows; Remove ring nut N5, index drum N4, and index ring R7, in that order. remove two nuts M3 pull or out index bearing sleeve E. The annular grease chamber in the longitudinal slide L, which has thus been made accessible, should then be cleaned with petrol and refilled with tease.

Slide

Release clamping screw T5 and remove screw S5. Pull our index head slide S. Clean all working surfaces, smear lightly with oil, cross slide Q can not be removed. Release clamping screw t1 and turn screw S4 to move the cross slide to its extreme positions. Clean the bearing surfaces, smear lightly with oil.

Swivel Arm

To remove the swivel arm and the index head as a unit remove the two nuts M4. Clean the bearing surfaces and smear them with oil.

Adjusting the Clamping Mechanism of Index Drum F.

After a major period of use clamping lever T6 should no longer lock swivel index drum F, screw U2 will have to be adjusted. For this purpose precede as follows: Remove swivel arm as described above; remove screw U3 and stop plate A1; back off nut M2 and screw U1 and pull out clamping lever T6. Lift off index drum F to pull out adjusting nut and screw U2 rotate screw 180° relative to nut to reduce the length-to reassemble parts reverse procedure.

Adjusting the Stop Pin for the 90° Swivel Motion

Ifm, due to constant striking of stop plate A1 against stop pin A2 and A3, the swivel range should no longer be exactly 90° correct the adjustment by turning the two eccentric stop pin A2 and A3. Turning stop pin A2 will change the cylindrical setting of the collect sleeve bearing, while turning stop pin A3 will adjust the 90° swivel motion.

Dressing the Grinding Wheel

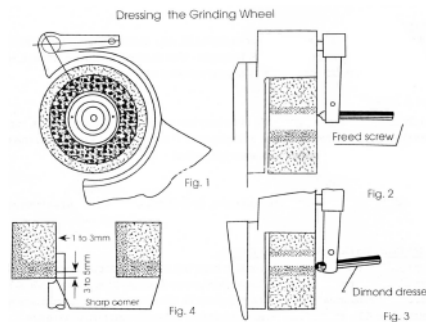
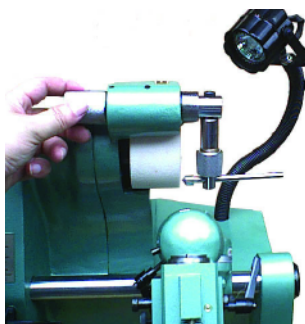

Wheel Turing and dressing should be performed at regular intervals. Dressing is done by means of a diamond set in a tip which is held in a rod. The latter is attached to a arm which is provided with a feed screw. The diamond tool assembly s supported by the wheel guard (see Fig. 1 and 2) wheel Turing and dressing is particularly necessary when the wheel has become headed or when sharp corner has been worn off. Failure to comply with rule will result in poor surface finish and overheating of the cutting tools.

Messing:

1. Loosen clamping nut D. Shift dressing diamond to the right. Swing the dressing attachment in front of the wheel rim.
2. Set diamond, dresser 1 mm in front of the wheel. Lock clamping nut D.
3. Turn Feed screw until the dressing diamond contacts the wheel. The layer to be dressed is 0.2mm. Give feed screw 1/5th turn.

Cutter Profiles-Tool Angle-Cutting Speeds

Cutter Profiles

As rule, single-lip milling cutters are given one of the seven basic profiles illustrated below:

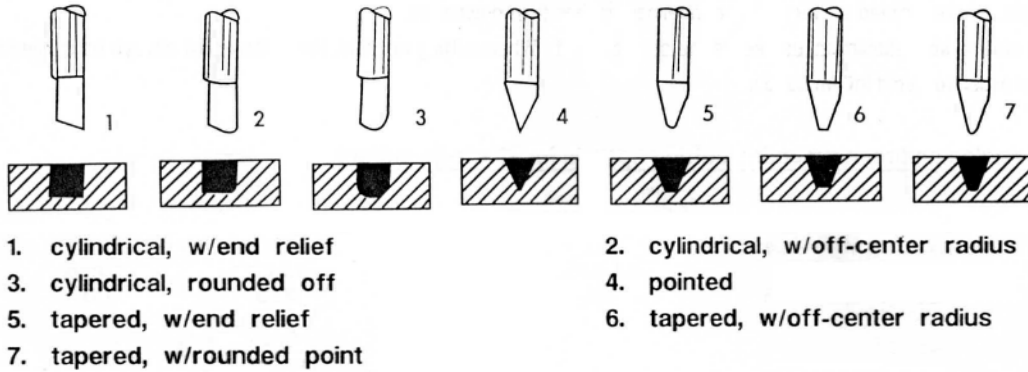

Above are illustrated the seven basic cutter profiles and cross sectional views of the profiles they will produce.

Material to be cut	Tool Angle			Recommended cutting speeds for high speed steel single lip cutter			
	α	β	γ	roughing cut		finish cut	
	25°	15°	5°	S.f.p.m	m/min	s.f.p.m	m/min
Cast steel				195	60	260	80
Malleable cast iron							
Machinery steel							
57,000 to 85,000 psi (40to60kg/mm)				230	70	295	90
85,000 to115,000 psi(80kg/mm)				195	60	230	70
Over 115,000 psi(80kg/mm)				130	40	165	50
Tool steel soft				195	60	260	80
grade hard grade				165	50	230	70
Brass, 58/41 soft				655	200	820	250
Grade hard grade				820	250	1150	350
Brass,63/37soft	30°	15°	5°	395	120	490	150
grade Hard grade				490	150	590	180
Bronze soft grade				525	260	655	220
Hard grade				655	200	755	230
Aluminum soft	35°			655	200	985	300
Grade hard grade				820	250	1150	350
				985	300	1150	350
Wood	25°	15°	5°				
Plastic: Trogon	35°			820	250	985	300
Pertinaz,Fiber	45°	25°	20°	688	200	820	250
Astral on, Celluloid				655	200	985	300
Plexus				655	200	1150	350

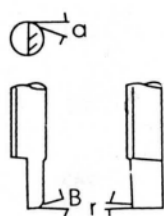

Cutter with end relief.

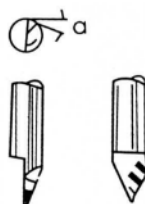

Cutter with pointed end.

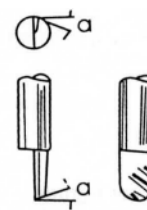

Rounded off cutter.

Tool Angles

As is the case with all metal cutting tools, single-lip milling cutters require the proper amount of cutting edge relief or back rake angle for maximum stock removal and high surface finish. As regards single-lip cutters, three different tool angles will have to be taken care of, these angles being used in all kinds of cutters.

Angle β applies to end relieved cutters only. Cutters having an angle of less than 20° should be relief ground at between 25° and 30° .

Cutter Speeds

As regards single-lip milling cutters, it is recommended to use cutting speeds three times higher than those used with standard type milling cutters. The data tabulated on the below should be used as a guide only. As such factors as drive conditions and available spindle speeds will also have to be taken into consideration. In end cutting edges the cutting speed will decrease forwards the cutter center line. This effect is particularly noticeable in rode-off cutter. As a consequence, care should surfaces are concerned, rather than downward.

When cutting soft aluminum, use kerosene as a coolant. When cutting celluloid, the cutter must always be in feed motion, in order to avoid inflammation.

Tool angles recommended cutting speeds for single-lip cutters

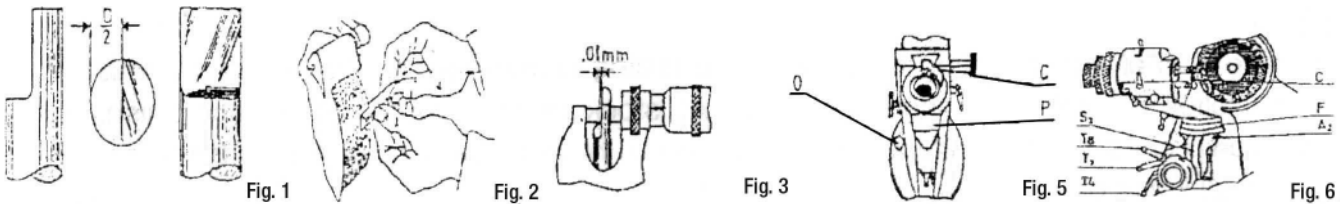

Centering the Cutter Lip by Grinding

Cylindrical single-lip milling cutters are supplied by the manufacturer with the lip preformed by rough milling (see Fig. 1). As a result, the cutter lip will first have to be accurately centered by grinding. Rough grinding of the lip is performed manually by holding the cutter against the circumference of the grinding wheel (see Fig.2). This operation is followed by finish grinding in the machine. The off center tolerance is $\pm .0004$ "(0.01mm), which should be checked with a micrometer caliper (see Fig.3). To grind the cutter lip correctly, proceed as follows:

Setup Operations

1. Set swivel arm and index drum F at zero, tighten clamping lever T3; set vertical setting scale S2 at zero, tighten clamping lever T2 (see Fig.4).
2. Bring white dot into window O, have index pin P engage the short-slot (see Fig 5).
3. Set cutter with aligning gauge C clamp cutter in position, rectum aligning gauge C (see Fig.6).
4. Withdraw index pin Prostate spring collect bearing 180° , allow index pin P to engage the short-slot.
5. Shift index head bracket along tubular guide to bring cutter lip into light contact with end face of grinding wheel. Be sure prior to tightening clamping lever T7, to align vertical swivel mount index mark with tubular guide. Tighten clamping lever T7, release clamping lever T4.

Centering the Cutter Lip

6. Fine adjustment screw H serves to set the index head accurately relative to the wheel and to provide the desired depth of cut. The travel of the cutter past the wheel can be limited by means of adjustable stop screw G. Thus it is possible, during grinding to advance the cutter as far as it will go. To bring the cutter lip within the prescribed off-center tolerance, reciprocate the index head bracket while advancing the cutter by rotation fine adjustment screw H.

In order to prevent the cutter from being overheated, it is recommended to leave only a narrow cutting zone on the grinding wheel (see page 5 "Dressing the Grinding Wheel"). The length of the cutter lip should equal one and one half times the diameter of the cutter.

It is not advisable to increase the length of the cutter lip beyond a certain limit. In the case of deep engraving work where stepped cutter are used the shank of the cutter will be increased instead of the lip.

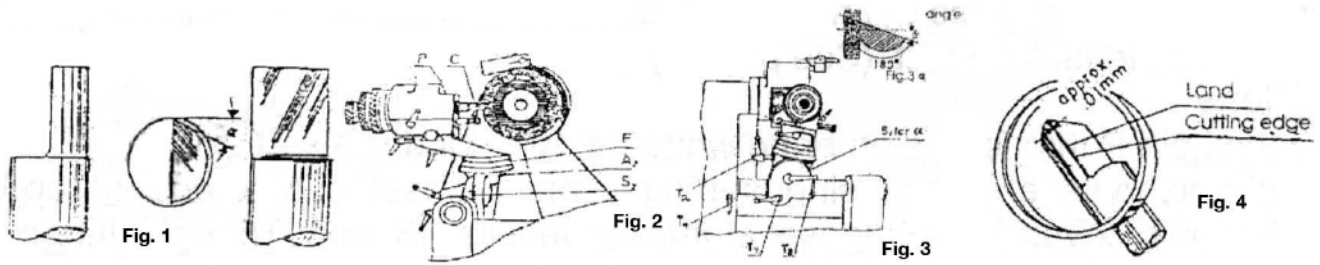

Circular Grinding of Cutters- Grinding the Back Angle of Side Cutting Edges

After centering the lip it will be necessary to grind the back rake angles of both the side cutting edge and the end cutting edge. The back rake angles of both cutting edges should be selected to suit the material to be cut.

Setup Operations

1. Rotate swivel arm to set index F at zero; tighten clamping lever T3.
2. Bring white dot into window Unengaged index pin P into long slot.
3. Align cutter by means of gauge C; grip cutter in position return gauge C (see Fig.2).
4. Release clamping lever T2; set swivel arm at desired back rake angle using setting scale S2;tighten clamping lever T2 (see Fig.3).
5. Tighten clamping lever T4; release clamping lever T7; shift work fixture on tubular guide to bring cutter into light contact with grinding wheel, tighten clamping lever T7; release clamping lever T4.

Circular Grinding

6. Draw index pin P out of the slot; grind desired diameter by rotating spring collet bearing through 360° . During this operation slowly rotate adjustable stop screw G, while continuously rotating the spring collet bearing, to advance the work fixture past the grinding wheel; this will produce uniform stock removal. Fine adjustment during circular grinding is by screw H. Stop screw G is used to establish the length of the cylindrical portion which should always be slightly longer than the cutting lip.
7. Return white dot into window Unengaged index pin P into short slot to enable bearing to be rotate 180° between the index plate stops.

Grinding the Back Rake Angle

8. When grinding the back rake angle, use the fine adjustment screw H over the entire range of rotation of the collet bearing (see Fig.3a). Grinding of the back rake angle is positive controlled. The angle is required to extend over the entire length of the cutting lip.

The vertical swivel bearing, which permits the work holding fixture to be swung back, enables relief angles up to 40° to be produced. Relief angles over 40° can be obtained by additionally rotating the collet bearing in the index head.(Only for cylindrical or tapered cutter with straight end cutting edges or for pointed cutters.)Upon completion of grinding operations a very narrow land must remain at the cutting edge (see Fig.4).

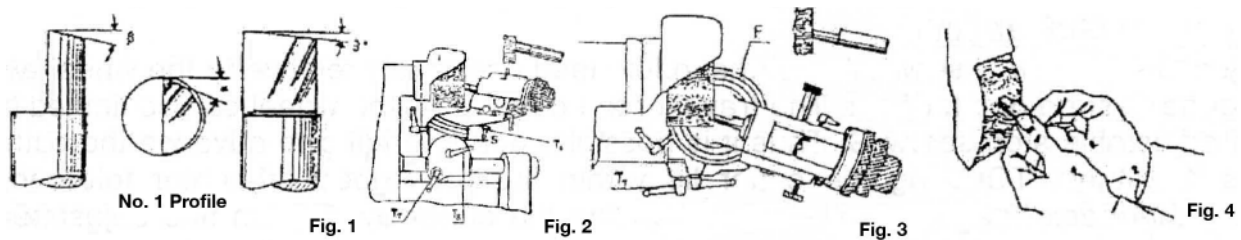

Circular Grinding of Cutters- Grinding the Back Angle of End Cutting Edges

The end cutting edge illustrated in Fig. 1 may be ground in an operation immediately following the grinding of the side cutting edge; or it may be ground independently. In the latter case the cutter will have to be aligned by means of gauge and clamped in position. Whenever a single-lip cutter is to be ground, the aligning will have to be used, as one leg of the cutting angle should be selected to suit the material to be cut..

Setup Operations

1. Engage index pin P into long slot; bring white dot into window O.
2. Release clamping levers T2; using setting scale S2, set swivel arm at approx. 30°; tighten clamping lever T2.
3. At desired angle; for example set arm at 75° for back angle of 15° (see Fig.2 and Fig.3). Tighten clamping lever T3 and T6.
4. Tighten clamping lever T4; release lever T7; shift work fixture on tubular guide to bring cutter into light contact with grinding wheel; tighten clamping lever T7; release lever T4.

Grinding the Back Rake Angle

5. Fine adjustment screw H serves to set the index head laterally reactive to the wheel and to set the work for the desired depth of cut. It is also possible to produce the desired back rake by holding the cutter against the circumference of the grinding wheel as is shown in Fig.4.

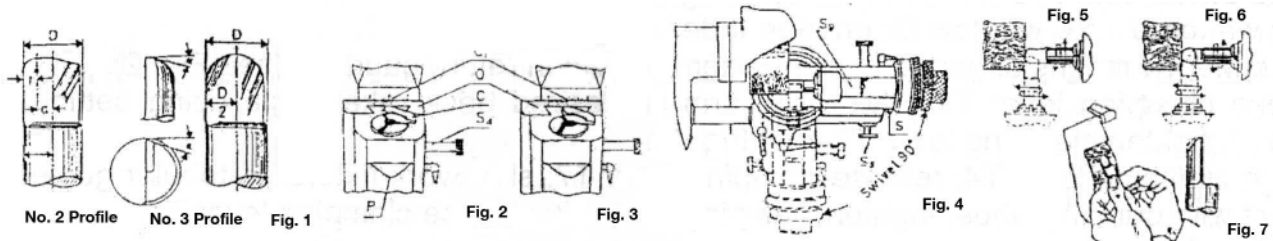

Circular Grinding of Cutters – Grinding the Back Angle of End Cutting Edges (Round)

Cutter profiles having either on-center or off-center radii are derived from cylindrical single-lip cutters having a straight end cutting edge by rounding off the corner as shown in Fig.1(No.2 and 3 profiles).

For this reason it is necessary, during grinding the end rake angle, that the work fixture is set at the side rake angle by means of setting scale S2. If the end cutting edge is ground immediately after grinding the side setting edge, it will not be necessary to reset the work fixture and to re-align the cutting lip by means of gauge C.

Setup Operations

1. Engage index pin P into short-slot; bring white dot into window O.
2. a. No.2 profile : Release clamping lever T1; rotate knurled knob S4 to set cross slide by means of vernier scale C1 for desired radius (to the right); tighten clamping lever T1,9 see Fig.2) as the radius corner is required to be tangent to the cutter diameter, the amount of off-set

$$\text{“a” is : } a = D / 2 - r$$

$$\text{Example: Given } r=.06\text{”}(1.5\text{mm}); D=.30\text{”}(8\text{mm})$$

$$A=.15\text{”}(4\text{mm})-.06\text{”}(1.5\text{mm})=.09\text{”}(2.5\text{mm})$$

- b. No.3 profile: The vernier scale C1 of the cross slide must be set zero (see Fig. 3).
3. Rotate fine adjustment screw H to bring the side cutting edge of the cutter into light contact with the face of the grinding wheel. Caution: do not injure the land of the side cutting edge. Now screw H must no longer be rotated.

Grinding the Back Rake Angle

4. Swivel index head through 90° (see Fig.4). Depth of cut adjustment now is by index head slide S1. Fine adjustment is by micrometer screw S6 of the index head slide with adjustment screw S5 tightened. The end of the cutter is rounded by slowly swiveling the index head back to its original position. While the cutter bearing is continuously rotated back and forth between the stops, the rotation being through 180° (see Fig.5 and 6). Prior to grinding, be sure to withdraw the index head a slight amount by rotating screw S in order to prevent overheating of the cutter by excessive stock removal. After each pass of the grinding wheel the cutter is then fed toward the wheel by means of screw S.

In order to obtain a satisfactory cutting edge it is advisable, as a final operation, to swivel the index head through 90° with the cutters given a No.3 profile are intended for the machining of hard steel which requires a small back rake angle, it is good practice to flatten the curvature of the cutter by a manual grinding operation as shown in Fig.7.

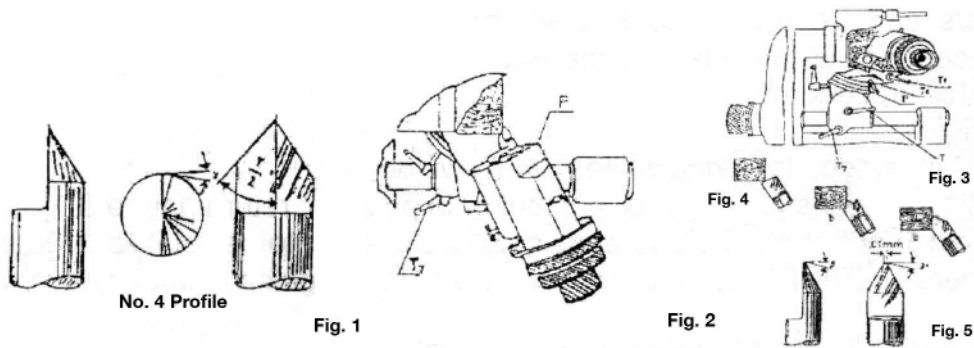

Grinding Pointed Cutters

Where pointed cutters are concerned, both the included angle of the point and the aback rake angle are produced in one operation (see Fig. 1). The back rake angle should be selected to suit the material to be cut.(see page 5)

Setup Operations

1. Engage index pin P into long slot; bring white dot into window O.
2. Align cutter lip by means of gauge 'C'; grip cutter in position; return gauge C.
3. Engage index pin P into short slot to enable collet bearing to be rotated 180° between stops.
4. Release clamping levers T3 and T6 hold index drum F against stop and, beginning at zero position. Set swivel arm at one half the desired point angle (see Fig.2).
Example: Given a point angle of 60° Set swivel arm by index drum F at 30° .Retighten clamping levers T3 and T6.
5. Release clamping lever T2; set work fixture for desired back rake angle by means of sitting scale S2, see Fig.3. Tighten clamping lever T2.
6. Tighten clamping lever T4; release lever T7; shift work fixture on tubular guide to bring cutter into light contact with grinding wheel tighten clamping lever T7; release lever T4.
7. During grinding slowly return stop screw G to advance the work fixture past the wheel; at the same time continuously rotate the collet bearing back and forth between the stops, the rotation being through 180° This ensures uniform stock removal (see Fig.4a, b, c,) Uniform stock removal will protect the cutter from overheating. Whet the cutter point by means of an oil stone. It is advisable to whet the point as far as engraving conditions permit. This operation will give the point a small end cutting edge which will participate in removing stock (See Fig. 5). However, where airline engraving work is concerned (depth of cut not exceeding .0004"(.01mm) the shape of the point should not be changed; only the cutting edge proper should be carefully whetted.

However, care should be exercised not to remove noticeable amounts of stock from the cutting lip, as this would destroy the centering of the lip; moreover, this would render a greater or lesser part of it useless. When grinding the cutting lip for the first time, care has to be taken to grind with a positive tolerance.

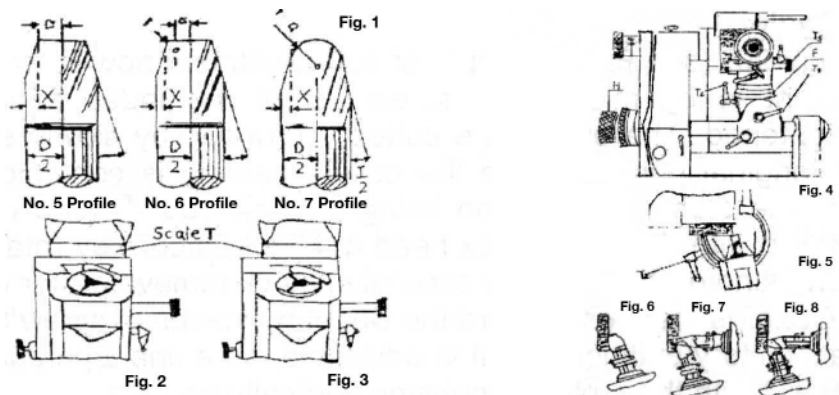

Grinding Tapered Cutters- Circular Grinding of side and End Cutting Edges

Tapered cutters can be ground to size in the machine without the use of any measuring instrument, except for the scales provided on the machine. For circular grinding operations on profiled cutters follow this procedure:

Setup Operations

1. Engage pin C into long-slot; bring white dot into window O.
2. Align cutter lip by means of gauge 'C'; grip cutter in position; return gauge C.
3. Draw index pin P out of slot hole to enable collet bearing to be rotated through 360° Release clamping levers T2,T3,T6. Set scale S2 and F at zero. Tighten clamping levers T4,T2,T3,T6 see Fig.
4. Release clamping lever T7; bring cutter diameter into light contact with grinding wheel; tighten clamping lever T7, taking care to keep index mark of vertical swivel mount aligned with tubular guide; release clamping lever T4, see Fig.4.
5. a.No.5 profile 9 Fig. 1 and 2):Release clamping lever T1; rotate knurled knob S4 to shift cross slide to the right by one-half of dial the taper ('a'in Fig.1). For this purpose use cross slide vernire scale T.Tighten clamping lever T1.
b.No.6 profile (Fig. and 2):Release clamping lever T1; rotate knurled knob S4 to shift cross slide to the right by the desired amount "a"(use cross slide vernier scale T). Tighten clamping lever T1.
c.No.7 profile (Fig. 1 and 3):Set cross slide vernier scale at zero.
6. a.No.5 and 7 profiles: Rotate fine adjustment screw H to bring cutter diameter into light contact with grinding wheel: again rotate screw H to shift cutter to the left by amount $x = D/2 - a$. To facilitate this setting operation, set scale drum of screw H at zero without disturbing the setting of the screw (see Fig.4).
b.No.6 profile: Rotate screw H to bring cutter diameter into light contact with grinding wheel; again rotate screw H to shift cutter to left by the amount $x = D/2 - (a+r)$. To facilitate this setting operation, set scale drum of screw H at zero without disturbing the setting of the screw (see Fig.4).
7. Release clamping lever T3; rotate swivel arm through 90°; release clamping lever T5; rotate index head slide micrometer screw S to advance end face of cutter towards grinding wheel. Wheel tapered cutters are to be resharpened, the length of the cutting edge at the end of the cutter should be made greater than the small diameter of the tapered portion.
8. Release clamping lever T6; hold index drum F against its stop and counting from the zero position, set swivel arm at the desired taper angle; tighten clamping lever T3 and T6, see Fig.6.
9. a.No.5 profile: Slowly return stop screw G and continuously rotate the collet bearing through 360° to advance the cutter past the grinding wheel. Prior to the circular grinding operation rotate fine adjustment screw H to shift the cutter to the right; the advance the cutter towards the wheel by small increment until the desired size has been obtained (see Fig.6).
b.No.6 and 7 profiles: Release clamping lever T3; first slowly return stop screw G, then slowly swing the swivel arm while continuously rotating the collet bearing through 360° to move the cutter past the wheel and thus to circular grinding operation rotate fine adjustment screw H to shift the cutter to the right; then advance the cutter towards the wheel by small increments until the desired size has been obtained (see Fig.7 & 8).

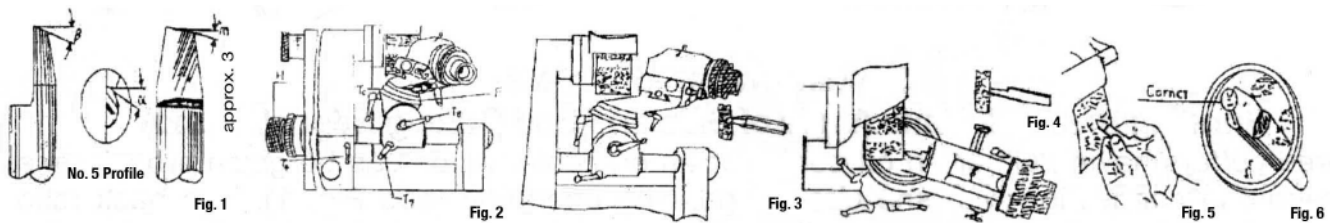

Circular Tapered Cutters- Grinding the Back Angle of Side and End Cutting Edges

The back rake angles of the side and end cutting edges may be ground immediately after circular grinding the desired cutter profile; or in cases where only the taper angle (not, however, the small diameter of the tapered portion) is of importance, grinding may be performed in an independent operation. Where the small taper diameter must be held within close tolerances, only the end cutting face will be ground; in this case the cutter will have to be by gauge C and clamped in position. The back rake angles of the side and end cutting edges should be selected to suit the material to be cut. For toll angles refer to Fig. 1.

Grinding the Side Cutting Edge

Setup Operations

1. Engage index pin R into shoet-slot;bring white dot into window O.
2. Release clamping lever T2 using scale S2 set cutter at desired back rake angle; tighten clamping lever T2, see Fig.2.
3. Tighten clamping lever T4; release lever T7; T4; release lever T7; shift work fixture on tubular guide to bring cutter into light contact with grinding wheel tighten clamping lever T7, taking care to keep index swivel mount aligned with tubular guide;release clamping lever T4.

Grinding the Back Rake Angle

4. While continuously rotating the collet bearing through 180° (back and forth between the stops), advance the cutter towards the grinding wheel by means of fine adjustment screw H. This will produce the desired back rake angle in a positively controlled operation (see Fig.2). Upon completion of the grinding operations on the side cutting edge, a very narrow land must remain at the edge.

Grinding the End Cutting Edge

Setup Operations

1. Engage index pin P into short-slot; bring white dot into window O.
2. Release clamping lever T2; using scale S2, set swivel arm at an angle of approx.3; tighten clamping lever T2, see Fig.3.
3. Release clamping lever T# ND t6; Hold scale F against its stop and beginning at the 90 –position, set swivel arm at the desired angle; for example where an angle of 10 is desired, the swivel arm will have to be set at 80 . Tighten clamping levers T3 and t^, see Fig.4.
4. Tighten clamping lever T4; release lever T7; shift work fixture along tubular guide to bring end face of cutter into light contact with grinding wheel;tighten clamping lever T7, taking care to keep index mark of vertical swivel mount aligned with tubular guide; release clamping lever T7.

Grinding the Back Rake Angle

5. Lateral fine adjustment of the work fixture relative to the grinding wheel and adjustment for depth of cut is obtained by means of screw H. It is also possible to grind the back rake angle manually; care should however, be taken to produce the correct tool angles (see Fig.5).

In cases where close tolerances on the small taper diameter after grinding edge will have to be maintained; this will make it possible to check whether or not the small taper diameter was changed during grinding operations (see Fig.6)

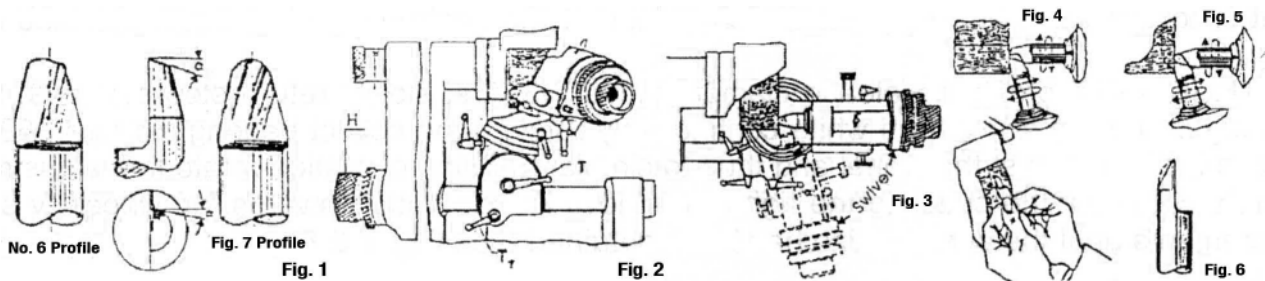

Grinding Tapered Cutters- Grinding the Back Rake Angle of Side and End Cutting Edges (Round)

Tapered cutters having either an off-center or an on-center radius can be given a back rake angle only in connection with the circular grinding operation (see Fig.1). The back rake angle of the side cutting edge equals that of the straight or coudec end cutting edge; the proper angle to be used will be found in page 5. After tapered cutters with rounded end cutting edges have become dull, first proceed with the circular grinding operation described on page 12; then follow the procedure indicated below.

Setup Operations

1. Engage index pin P into short slot; bring white dot into window O.
2. Release clamping lever T2; use scale S2 to set work fixture at desired back rake angle; tighten clamping lever T2. Tighten clamping lever T4; release lever T7; shift work fixture along tubular guide to bring cutter into light contact.
3. With grinding wheel; tighten clamping lever T7, taking care to keep index mark of vertical swivel mount aligned with tubular guide; release clamping lever T4. (see Fig.2).

Grinding the Back Rake Angle

4. While continuously rotating the collet bearing through 180 (back and forth between the stops), advance the cutter towards the grinding wheel by means of fine adjustment screw H. This will produce the desired back rake angle on both side and the end cutting edges in a positively controlled operation (see Fig.3,4,5). Upon completion of grinding operations, a very narrow land must remain at the cutting edge.
5. In cases where the cutter is intended for the machining of hard steel which requires a small back rake angle, it is advisable to grind off part of the curvature in a manual operation (see Fig.6). In addition it is recommended, with regard to all single lip cutters, to whet also the cutting lip by means of an oil stone in order to remove burrs. However, care should be exercised not to remove noticeable amount of stock from the cutting lip, as this would destroy the centering of the lip; moreover, this would render a greater or lesser part of it useless.



ACCESSORIES

STANDARD EQUIPMENT		SPECIAL ACCESSORIES (ON EMEND)	
1.Wheel mount(Flange)(C1)	1	1.Machine light	
2.cup wheel for grinding high speed cutter 100×50×20mm(C2)	1	2.Balance stand and arbor	
3.Driving belt (C3)	1	3.Diamond wheel for grinding carbide cutter	
4.Hex socket screw wrench(C4)	4	4.Twist drill grinding attachment	
5.Wheel lock pin(C5)	1	5.Lathe tools grinding attachment	
6.Aligning finger(C6)	1	6.End mill grinding attachment	
7.Spring collects(C7)	5	7.Special index head slide with clamping sleeves for grinding dial,20,25mm cutter	
8.Hock spanner(C8)	2	8.R8 spring collets:dia,3,4,6,8,10,12,16,18,20mm and 1/8',3/16",1/4",5/16",3/8",1/2",5/8",3/4"	
9.Wheel spanner(C9)	1	9.Driving belt.	
		10.High-speed cutter grinding wheel.	

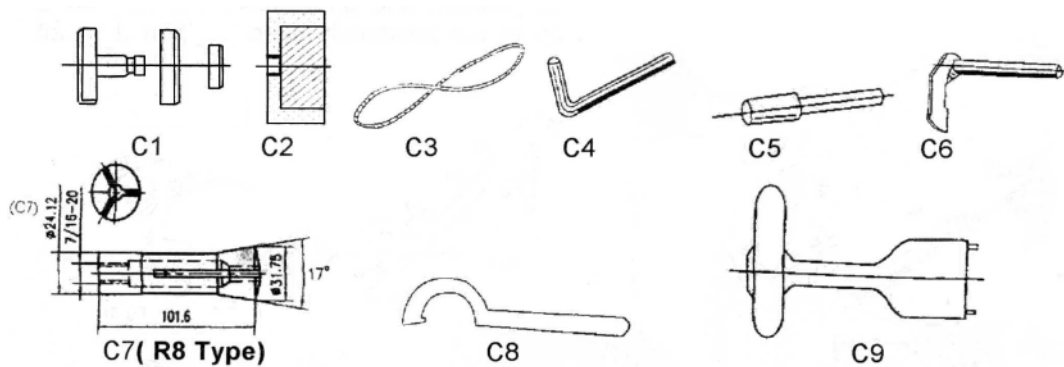

Twist Drill Grinding Attachment

The twist drill grinding attachment has been designed for grinding twist drills of 3 to 18 mm (1/8" to 11/16") diameter. The lip angle is always 116, while the back rake angle is adjustable as required.

To mount the attachment (see Fig.2), attach a 12 mm (1/2") spring collet to locating pin 1 and insert the collet into the index head slide of the index head bracket, introducing retaining pin 2 into the bore of the off-side setting gauge. Adjustable stop 5 has a flat surface on one side for holding twist drills of 3 to 18mm (1/8" to 11/16") diameter. The drill is held by hand against stop 5 and the swivel-mounted V-guide 4 during grinding (Fig.1). After backing off clamping screw 7, stop 5 with ring 999 can be pulled off (depress catch 10) and mounted in reverse position. This permits clamping of small drills (3 to 6mm or 1/8" to 1/4" dia.) by means of clamping screw 6, since experience has shown that such drills are difficult to hold by hand grinding.

Setup Operations

1. Release clamps K3 and K4. Hold index drum T4 against stop by means of the knob and set swivel arm at 13°. Retighten clamps K3 and K4.
2. Release clamp K2 and set swivel arm at zero on setting scale T2 (resulting in a normally suitable rake angle). If larger or smaller rake angles are required, adjust swivel arm accordingly. Retighten clamp K2. Release clamp K6 and screw D6. Move index head slide T until its front face roughly coincides with the front face of cross slide Q. Retighten clamp K6 and screw D6. Only if new grinding wheel is used :
3. Release clamp K5, move cross slide Q fully to the right using knurled screw S5. Retighten clamp K5. Release clamp 3 (on attachment) and adjust swivel-mounted V-guide 4 until the scale shows the diameter of the twist drill to be ground. Retighten clamp 3. Release clamp K1, tighten clamp K. Move index head bracket on the tubular guide until gauge plate 8 is in position approx. .04" (laterally of the face of the grinding wheel. Align vertical swivel mount index mark with reference line of tubular guide, then retighten clamp K1 and release clamp K. Place twist drill on V-guide 4. Back off clamping screw 7 and advance stop 5 until the cutting face of the drill rests against gauge plate 8, projecting approx. 0.02" (5mm). Tighten clamping screw 7. When using the adjustable stop in reverse position (for small twist drills of 3 to 6mm 1/8" to 1/4" dia.), tighten clamping screw 6.
4. Swivel twist drill grinding attachment upwards. Use fine adjustment screw F to advance the drill until it contacts the grinding wheel. Grinding first cutting edge by swivelling the attachment downward (Fig.3). Repeat feed and grinding operation if required.
5. Place twist drill into V-guide 4 in 180° inverted position and grind second cutting edge leaving the attachment and the adjustable stop in the previously used position (i.e. not advancing fine adjustment screw F).

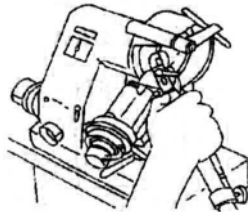

Fig. 1

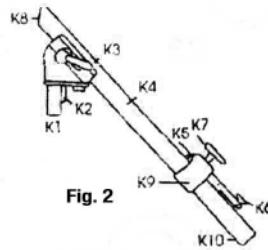

Fig. 2

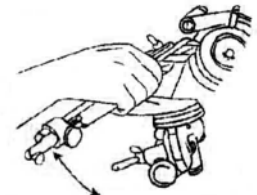
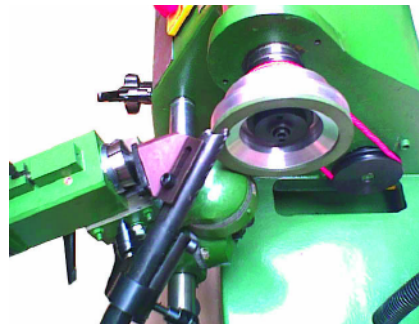
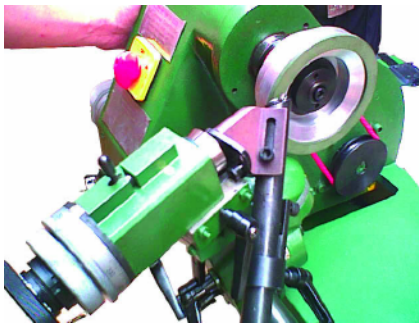
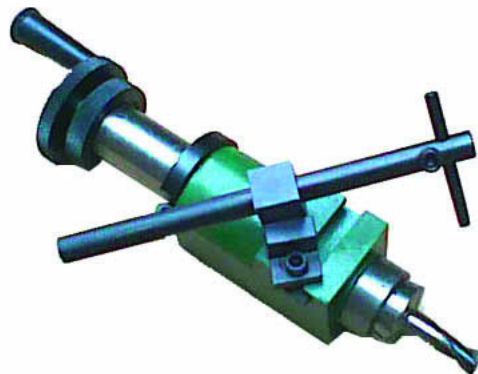

Fig. 3



INSTRUCTIONS FOR GRINDING AN END MILL



Change the original work head into End mill attachment work head.(as drawing I)
 Insert the suitable size U2 collet into the tapered hole of the end mill attachment work head.
 Insert the end mill into the U2 collet and faster it, So that the end mill will not turn.(as drawing II)
 Set the center of the wheel head at the height of the work head spindle center and locate the end mill top leaving about 5mm form grinding ding wheel (as drawing III)
 Swiving the end mill attachment work head by the degree of relief angle.
 Use the grinding guide pin to grinding the rake of end mill following the screw of end mill by the direction from front to back.(as drawing IV)
 To grinding the secondary relief angle when the primary relief angle grinding is finished ake the grinding guide pin into the screw groove of secondary rake then grinding same as first rake.
 Swivel the end mill grinding attachment horizontally by 90 degree then according the degree of end cutting edge angle of end mill for grinding the rake of the top angle of end mill. (as drawing IIv)

INSTRUCTIONS FOR GRINDING A LATHE TOOL BIT

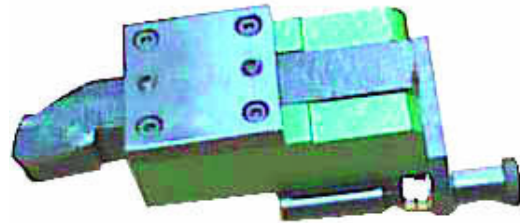
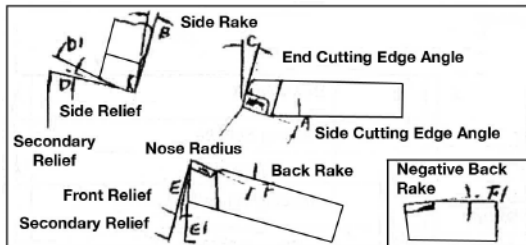

Change the original work head into Lathe tool attachment work head.(as drawing I)
 Insert the Lather tool bit into the Lathe tool attachment work head and fasten it, so that the Lathe tool bit will not move.
 Set the center of Lathe grinding attachment at the height of the grinding wheel of the spindle center. (as drawing II)
 Swivel the lathe tool grinding attachment horizontally by the degree of side cutting edge angle for grinding side cutting edge angel (A),Fix the angle the horizontal angle A then swivel the lathe tool grinding attachment vertically by the degree of side rake angle (B) for grinding side rake angle (as drawing III)
 Swivel the lathe tool grinding attachment horizontally by the degree of and cutting edge angle for grinding end cutting edge angel C),then fix angle for grinding end cutting edge angle ©
 The horizontal angle at angle A then swivel the lathe tool grinding attachment vertically by the degree of side relief angle (D) & secondary relief (D1) (as drawing IV)
 Swivel the lathe tool grinding attachment horizontally by the degree at original position then swivel the lathe tool grinding attachment vertically by the degree of front relief (E) and second relief (E2)
 Change the lathe tool bit by top-side face the grinding wheel, swivel the lathe tool grinding attachment horizontally by the degree of back angle negative back rake angle for grinding for grinding back rake (F) or negative back rake (F2)

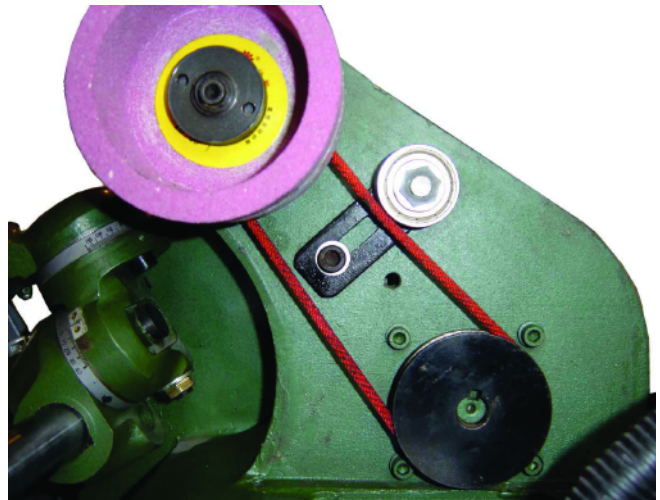
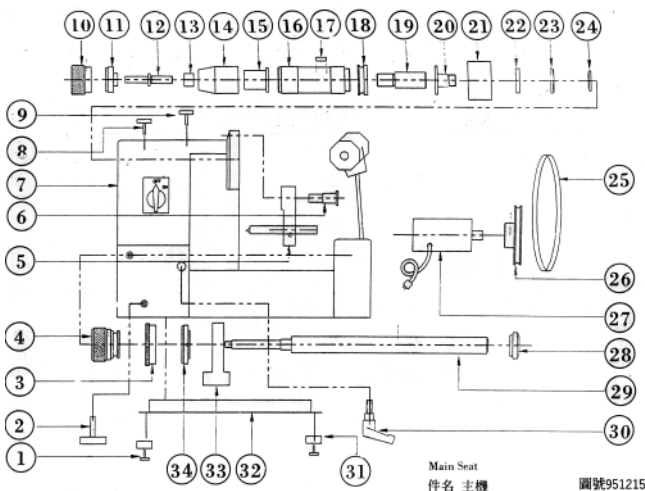

Main Seat

Index No.	Parts Name	Parts No.	Index No	Parts Name	Parts No.
1	Bolt		17	Belt Wheel	A4026
2	Font-Back Adjust screw		18	Passing Spindle	A4033
3	Degree Ring	A4016	19	Flange Screw	A4029
4	Turn Wheel	A4012	20	Grinding Wheel	
5	Wheel Dresser Handle		21	Flange Bracket	
6	Wheel Dresser	A4038	22	Flange Tighten Nut	
7	Seat	A4041	23	key	
8	Fixed Tighten screw		24	Drive Belt	
9	Fixed Tighten screw		25	Belt Wheel	A4004
10	Grinding Wheel-Turning Wheel	A4006	26	Motor	
11	Wheel Degree Ring	A4044	27	Right-Left Fixed Ring	A4014
12	\adjust screw		28	Right-Left Connected Level	A4023
13	Copper plate		29	Handle	
14	Spindle End Sleeve	A4045		Foot Cushion	
15	Passing Spindle Sleeve			Cover Board	A4042
16	Spindle Sleeve	A4017		Plate	A4037
				Right-Left Degree Ring	A4011

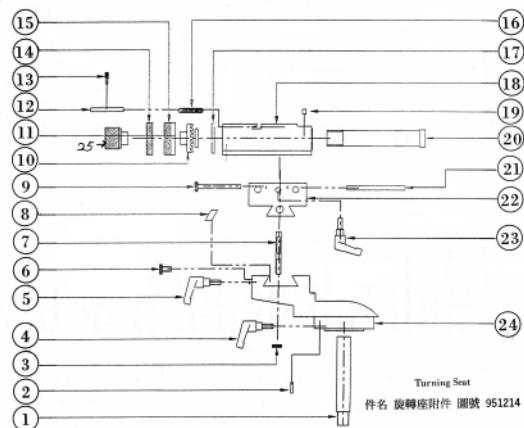

Turning Seat Attachment

Index No.	Parts Name	Parts NO.	Index NO.	Parts Name	Parts NO.
1	Leader Level		14	Tighten Screw	A4009
2	Fixed Screw		15	Front-Back Degree Ring	A027
3	Front-Back Micro Adjust Screw	A4016	16	Spring	
4	Adjust Fixed Handle	A4012	17	Reading Fixed Plate	
5	Handle	A4035	18	Collect Seat	A3005
6	Screw	A4041	19	Oil Ball	
7	Right-Left Fixed Screw		20	Collect	A4001
8	Key		21	Key	
9	Right-Left Micro Adjust Level		22	Seat	A3003
10	Gear	A4005	23	Handle	
11	Plate	A4038	24	Terning Seat	A3006
12	Dearer Bolt	A4030	25	Sleeve Tighten Nut	A4046
13	3-Speed Fixed Handle				

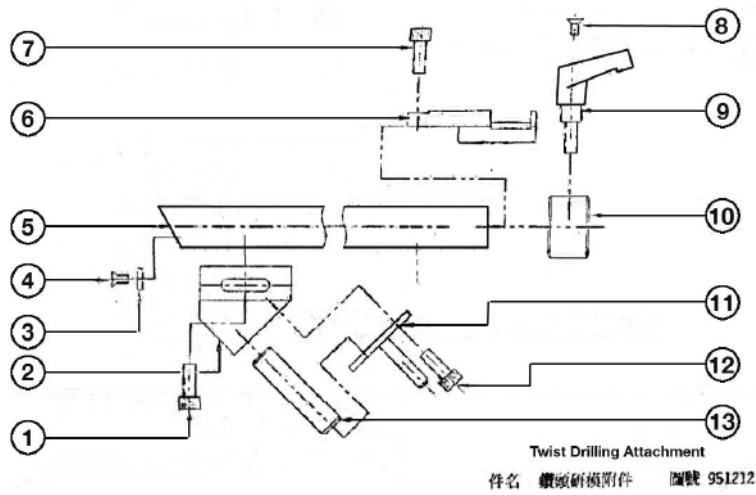

Twist Drilling Attachment

Index NO	Parts Name	Parts NO	Remarks	Index NO	Parts Name	Parts NO	Remarks
1	Bolt			8	Bolt		M6×12
2	Slip Block	A4036	M6×12	9	Handle		M3×15
3	Gradient Plate			10	Eccentric Ring	A4018	
4	Bolt		M4×8	11	Turn Plate		
5	Twist Drill Spindle	A4031		12	Bolt		
6	Slip Block			13	Collect Spindle		M1×12
7	Bolt			14			

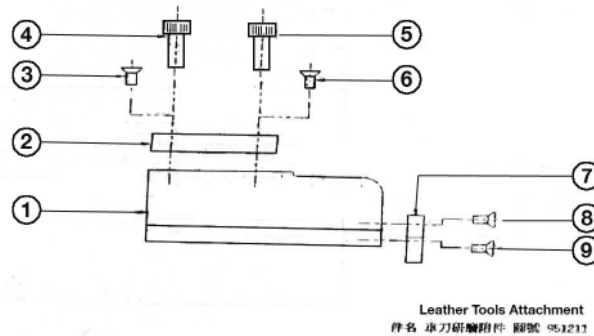

Leather Tools Attachment

Index NO	Parts Name	Parts No	Remarks	Index NO	Parts Name	Parts No	Remarks
1	Loath Seat	A3001		6	Bolt		M6×20
2	Fixed Board	A4020		7	Fixed Board	A4021	M4×12
3	Bolt			8	Bolt		M4×8
4	Bolt		M6×12	9	Bolt		M4×8
5	Bolt	A4031	M6×20				

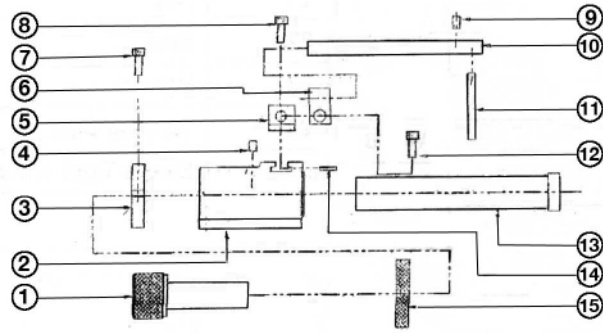

End Mills Attachment
 片名 立铣头附件 图号 951213

End Mills Attachment

Index NO	Parts Name	Parts NO	Remarks	Index NO	Parts Name	Parts No	Remarks
1	Collect seat Tighten Screw	A4019		9	Bolt		M5×12
2	Collect Seat			10	Adjust Level	A4032	
3	Tighten Ring	A4013		11	Adjust Level		
4	Oil Cup			12	Bolt		
5	Connect Block			13	Sleeve		M×25
6	Connect Block			14	Slip Block	A4003	
7	Bolt		M6×16	15	Tighten Nut		
8	Bolt		M6×16				

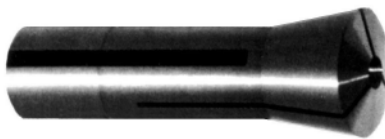
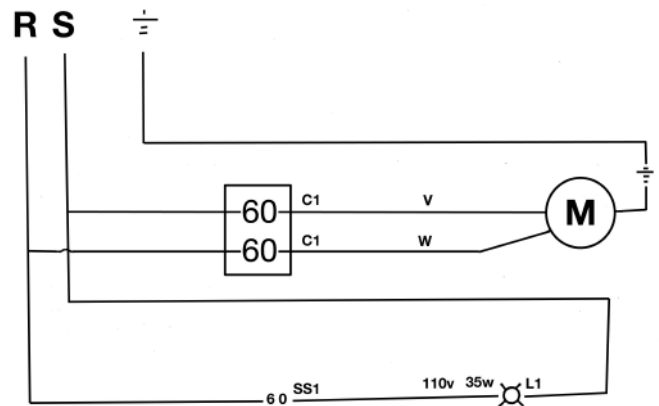
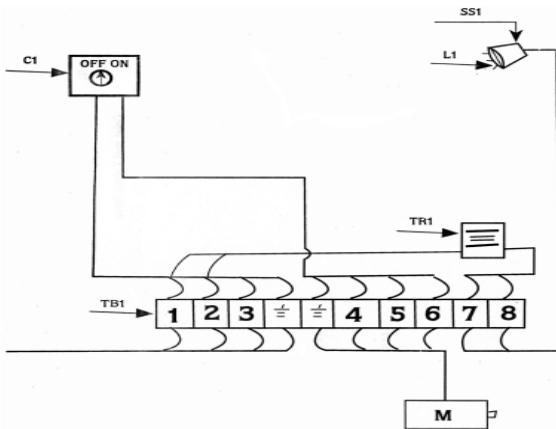

R8 COLLET